



# DESIGNLIGHT

SCANDINAVIAN AB

## DOWNLIGHT, TILT

E-NR: 74 657 46

ART NR: Q-2MW

EFFEKT POWER	MATERIAL MATERIAL	KELVIN KELVIN	ARMATURFÄRG ARMATURE COLOR	ANSLUTNING CONNECTION	TOTAL LUMEN	USEFUL LUMEN
4.4W WITH DRIVER	ALUMINIUM	2700K	MATT WHITE	230V	377LM	302LM

CE, ROHS, IP CERTIFIED BY SGS



LED 1x 3,2W LIGHT SOURCE WATT

LIFETIME L70B50: 50.000H

HÖG PRESTANDA

MONTERING DIREKT MOT ISOLERING

LEVERERAS MED KOPPLINGSDON/DRIVER

445 CD

FLICKER FREE

CRI: >80

25°

36°

IP20

IP44

70MM

H 35 MM

Ø80MM

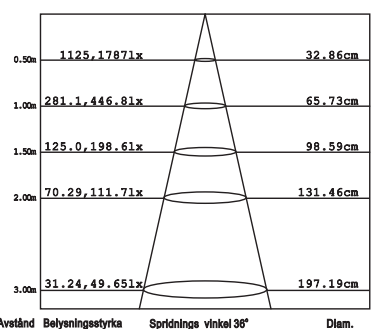
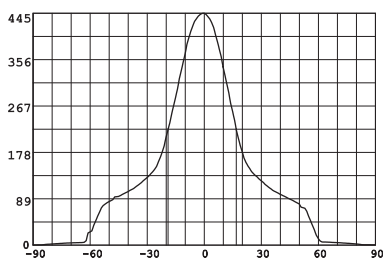
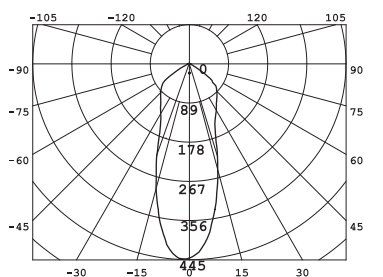

Avstånd Belysningsstyrka Spridningsvinkel 36° Diam.

### 1. Stäng av strömmen/Turn off the power

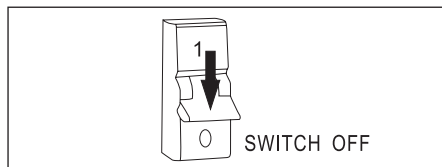

### 2. Borra hål i taket/Drill hole in ceiling

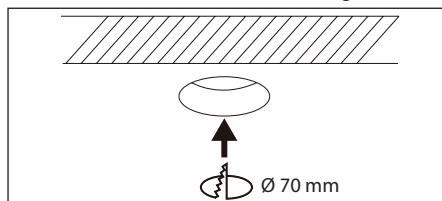

### 3. Anslut till LED-drivern/Connect to LED driver

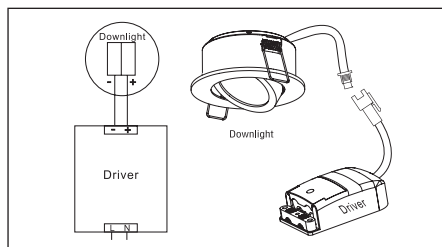

### Mått/Dimension

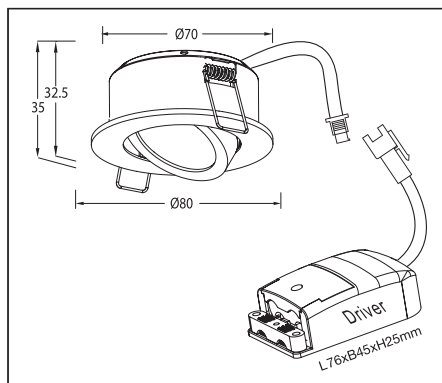

PRODUKTEN INNEHÅLLER  
LJUSKÄLLA MED  
ENERGIMÄRKNING  
KLASS F.

### ⚠ SÄKERHET:

- Läs igenom hela manualen noggrant före installation.
- Kontrollmät ALLTID diametern före håtagning i tak.
- Försäkra dig om att spänningen är fränslagen före installation eller underhåll.
- Installation ska utföras av behörig elektriker.
- Ljuskällan är ej utbytbar. Hela armaturen måste bytas när ljuskällan är förbrukad.

### ⚠ SAFETY:

- Read the entire manual carefully before installation.
- ALWAYS check the diameter before drilling holes in the ceiling.
- Make sure that the power is switched off before installation or maintenance.
- Installation must be performed by a qualified electrician.
- The light source of this luminaire is not replaceable, when the light source reaches its end of life the whole luminaire shall be replaced.

1.900K	2.700-3.000K	4.000-4.500K	4.800K	5.000-5.000K	7.000-7.500K	10.000K
STEARINLJUS CANDLE	VARMVIT WARM WHITE	NATURLIG VIT NATURAL WHITE	SOLLJUS DIRECT SUN	VITT DAGSLJUS DAY WHITE	KALLVIT COOL WHITE	BLÅ HIMMEL BLUE SKY

DESIGNLIGHT  
SCANDINAVIAN AB

DESIGNLIGHT SCANDINAVIAN AB · TOFFELVÄGEN 1 · 342 60 MOHEDA  
KUNDCENTER: TELEFON 0472-716 10 · FAX 0472-716 09 · INFO@DESIGNLIGHT.NU · WWW.DESIGNLIGHT.NU